

# ÇEVRE HESAPLAMALARI

Taralı kısmın çevresi kaç birimdir?

1)

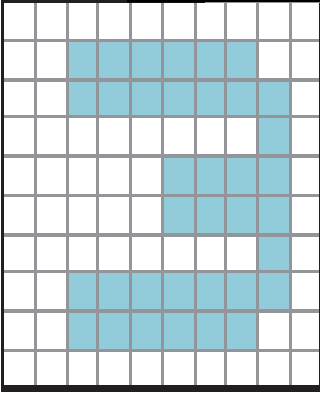

2)

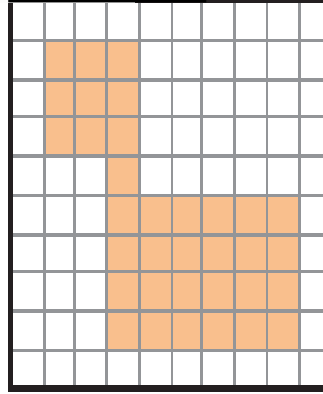

3)

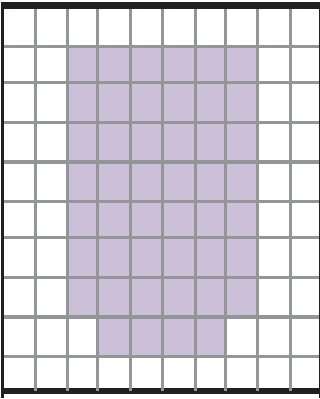

4)

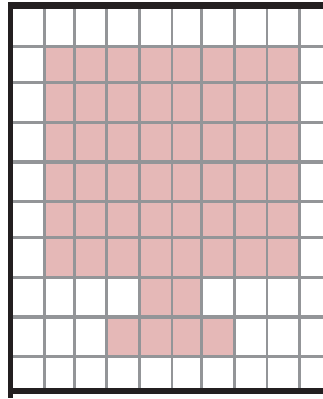

5)

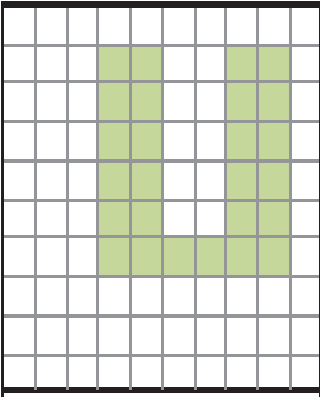

6)

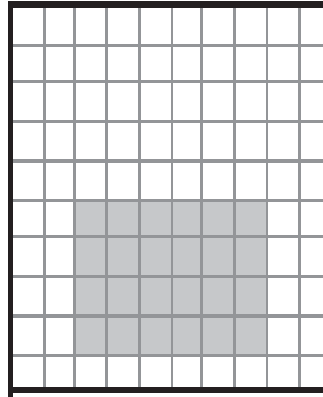

7)

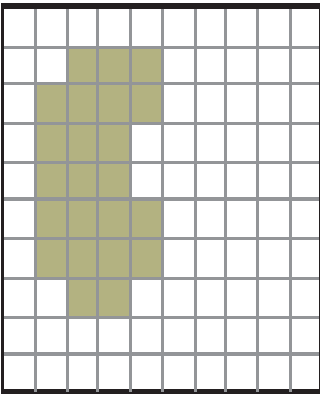

8)

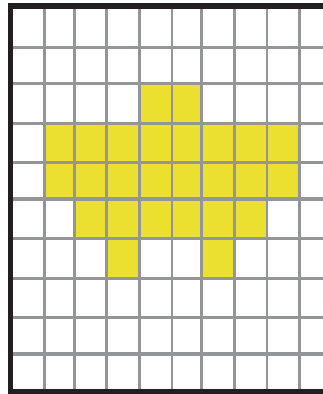

-ÇEVRE-

1. \_\_\_\_\_

2. \_\_\_\_\_

3. \_\_\_\_\_

4. \_\_\_\_\_

5. \_\_\_\_\_

6. \_\_\_\_\_

7. \_\_\_\_\_

8. \_\_\_\_\_

## ÇEVRE HESAPLAMA

Verilen şekillerin çevre uzunluğunu hesaplayınız.

1)

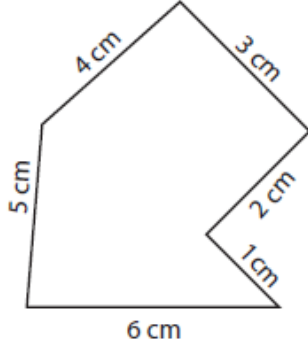

Çevre =

2)

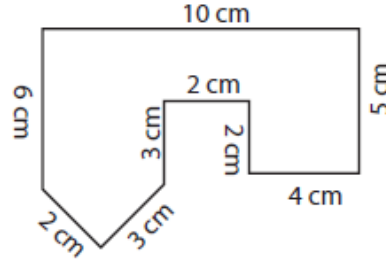

Çevre =

3)

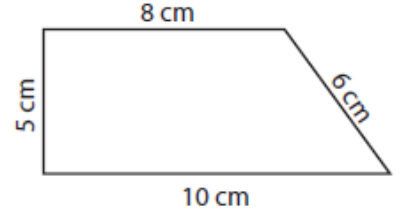

Çevre =

4)

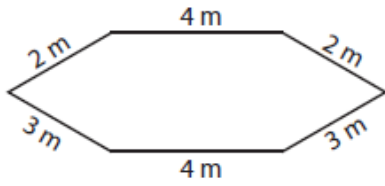

Çevre =

5)

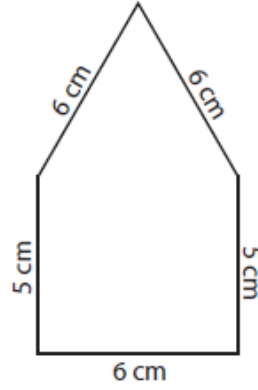

Çevre =

6)

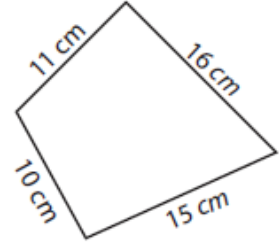

Çevre =

7)

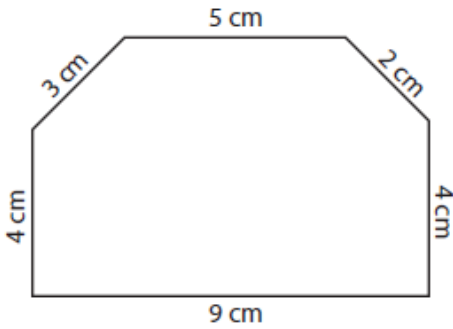

Çevre =

8)

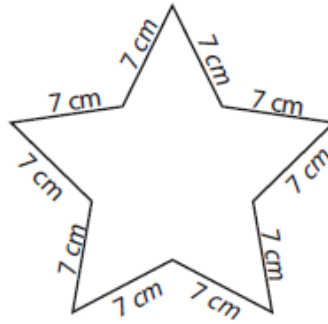

Çevre =

9)

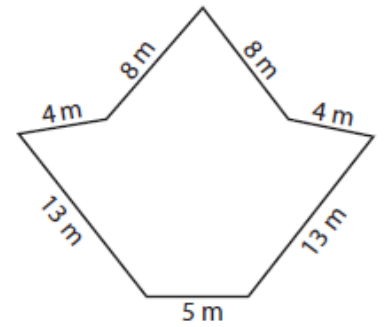

Çevre =

## ÇEVRE HESAPLAMA

Verilen şekillerin çevre uzunluğunu hesaplayınız.

1)

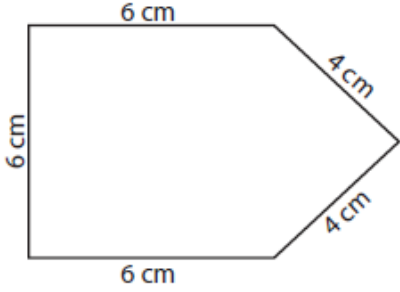

Çevre =

2)

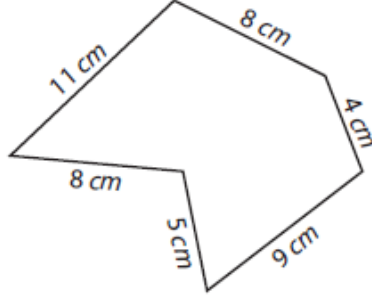

Çevre =

3)

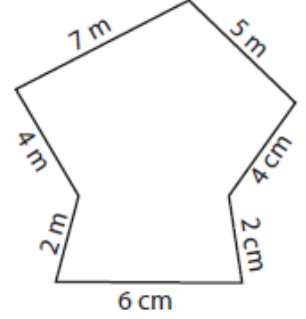

Çevre =

4)

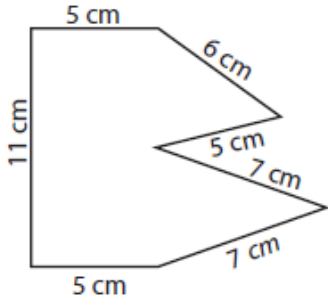

Çevre =

5)

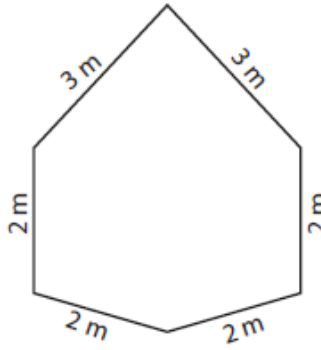

Çevre =

6)

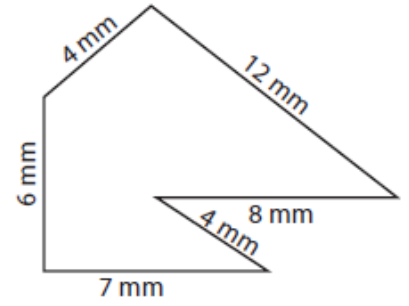

Çevre =

7)

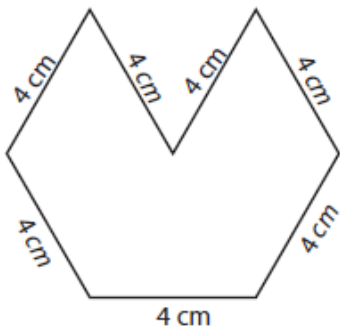

Çevre =

8)

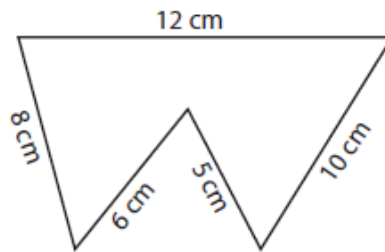

Çevre =

9)

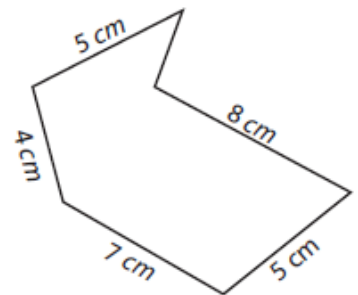

Çevre =

## YAZIM VE NOKTALAMA İŞARETLERİ

(Cümlelerin bazı kelimeleri ve noktalama işaretleri yanlış yazılmıştır,düzelterek tekrar yazın.)

1) ilknur, kuşunun adını maviş koydu.

2) Yolda dr. Ahmet beye rastladım

3) Türkiye'nin en uzun nehri kıvırmaktır.

4) Yaz tatilimi kuşadasında geçirdim

5) kış mevsimi doğu anadoluda sert geçer.

6) uzun yıllar Avrupada yaşamış

7) Dayımın oğlu üniversite sınavını kazanmış.

8) Gelirmi gelmezmi bilmiyorum?

9) Beni beklermisin?

10) Bu konuda ki fikirini beğendim.

11) Derdini söylemeyen derman bulamaz.

12) Barış dün akşam sipor için Bahcesipora gitmiş.

13) Kitapda güzel hikayeler var.

14) Buse dolapa peynir koydu.

15) Bu mutlu haberi herkeze duyuracağım.

16) Pikniğe sen de gelirmi sin!

17) Şiir yarışmasında 2.'nci olmuşum.

18) Sular evde demi akıyo.

19) Türk dil kurumu Atatürk'ün önderliğinde kuruldu.

20) Birsen hanım bir şey sormak için bize geldi.